

alea

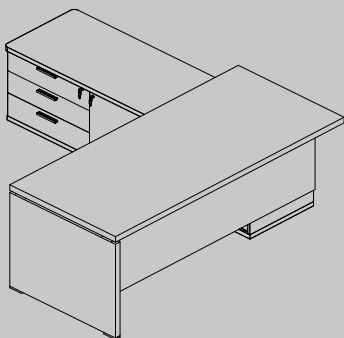

odeon

direzionali | executive | mobilier de direction | ejecutivos

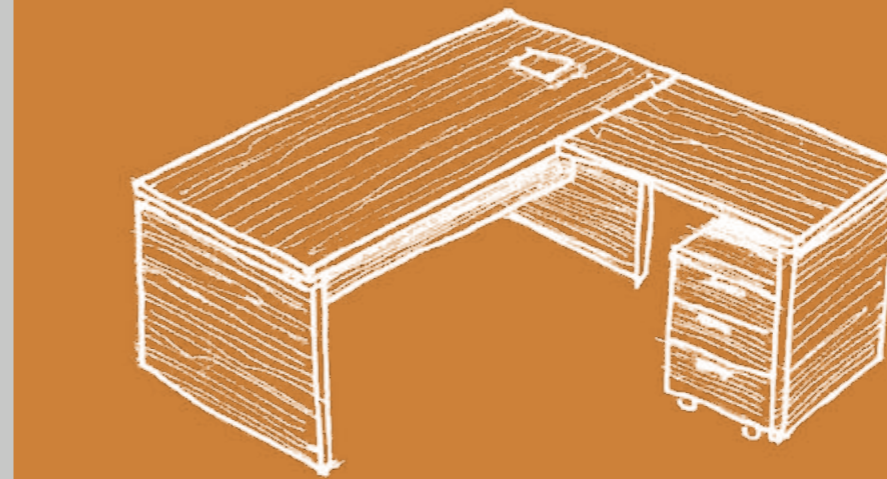

Abbiamo rinnovato un classico bestseller

inserendo nuove soluzioni e combinazioni di finiture

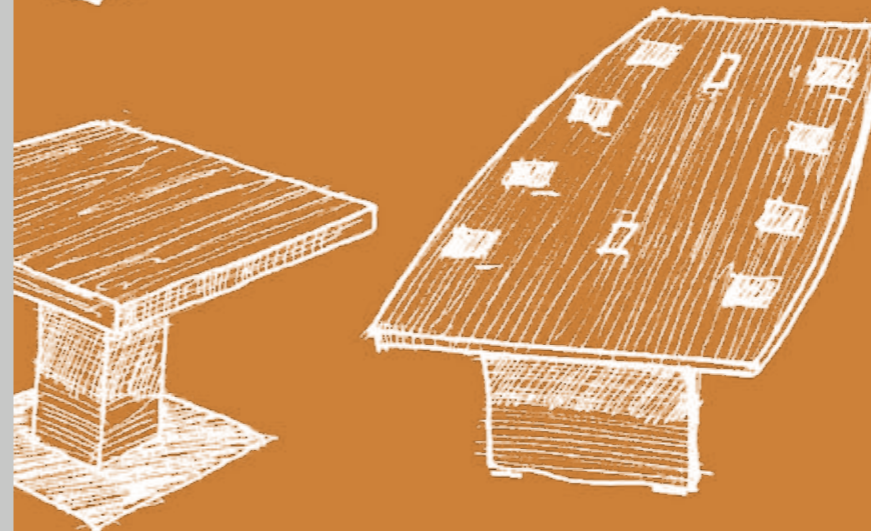
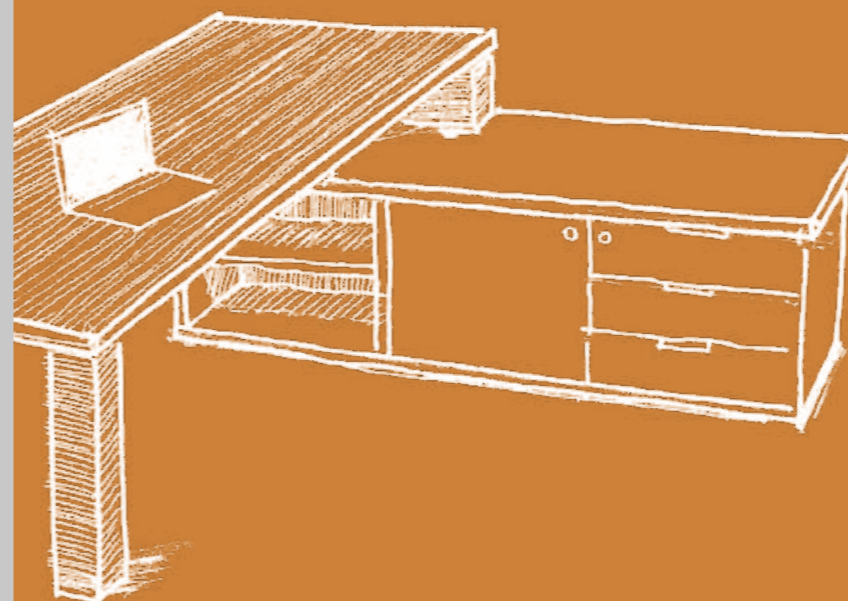

We have renewed a classic bestseller by introducing new solutions and combinations of finishes

Nous avons renouvelé un best-seller en intégrant de nouvelles solutions et combinaisons de finitions

Hemos renovado un clásico introduciendo nuevas soluciones y combinaciones de acabados

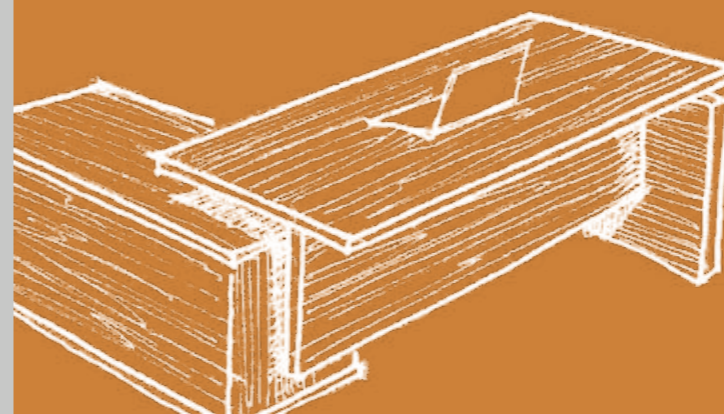



I structural storage Odeon managerial system, characterised by panel legs that support 40 mm thick worktops, has been combined with new structural storage with an open compartment, sliding door, CPU compartment and a choice of drawers. The storage features a false back to accommodate cables.

I rangements structurels au système exécutif Odeon, caractérisés par des pieds-panneaux qui supportent des plans de travail épais de 40 mm. un nouveau rangement structurel a été combiné avec un compartiment ouvert, une porte coulissante, un compartiment pour CPU et un module à trois tiroirs ou un tiroir de classement vertical. Le module de rangement a un double dos pour le passage vertical des câbles.

I muebles de servicio la colección ejecutiva Odeon se compone de patas-panel que soportan sobres de trabajo de 40 mm de grosor. Hemos combinado un nuevo mueble auxiliar estructural con vano abierto, puerta corredera, soporte CPU y cajonera 3 cajones o 1 cajon con archivador. El mueble está equipado con vano técnico para acceso al compartimiento interior para la subida de los cables.

/contenitori strutturali

Al sistema direzionale Odeon, caratterizzato da gambe pannellate che sostengono piani lavoro di spessore 40 mm, è stato abbinato un nuovo contenitore strutturale con vano a giorno, anta scorrevole, vano porta CPU e cassetiera tre cassetti o cassetto classificatore. Il contenitore prevede una doppia schiena per il transito verticale dei cavi.







/meeting tables a new family of meeting tables has been added. Square and rectangular tables with panel legs or round bases. To suite with the desk design we offer a folded column base, that also allows access for cables from floor to top if required. This rests on a painted steel base.

/tables de réunion une nouvelle famille de tables de réunion, carrées ou rectangulaires, a été ajoutée aux tables avec pieds panneaux et bases rondes en métal. Ces tables se caractérisent par un pied de colonne en tôle pliée et adaptable au passage vertical du câblage grâce à des rabats spéciaux. La colonne repose solidement sur une plaque métallique peinte.

/mesas de reuniones hemos adjuntado una nueva línea de mesas de reuniones. Las nuevas mesas de reunión pueden ser cuadradas o rectangulares y se caracterizan por la columna cuadrada que soporta el tablero realizada en "folding" y adaptable al tránsito vertical del cableado gracias a los pasacables. La columna apoya sobre base metálica cuadrada realizada por una pletina de metal pintada.

/tavoli riunione

Una nuova famiglia di tavoli riunione, quadrati o rettangolari, si è aggiunta ai tavoli con gambe pannellate e basi metalliche rotonde. Sono caratterizzati da un basamento a colonna realizzata in folding e adattabile al passaggio verticale del cablaggio grazie ad appositi passacavi. La colonna poggia solidamente su una piastra in metallo verniciato.









/integrazione

Le scrivanie Odeon si abbinano a tutte le librerie e ai contenitori del catalogo Alea. L'interazione di stili e materiali tra gli elementi di diverse collezioni, fornisce costantemente nuove fonti di ispirazione. Librerie Titano e credenze Blade infatti, si integrano con la scrivania alla perfezione.

***Integration** Odeon desks suite with all the bookcase and storage options in the Alea portfolio. Design and material finishes are common across the ranges to fuel inspiration. Titano bookcases and Blade credenzas perfectly complete the solution.*

***l'intégration** les bureaux Odéon se marient bien avec toutes les bibliothèques et rangements du catalogue Alea. L'interaction en terme de style et de matériau entre les éléments des différentes collections fournit constamment de nouvelles sources d'inspiration. Les bibliothèques Titano et les crédences Blade s'intègrent parfaitement avec le bureau.*

***Integración** los escritorios de Odeon se combinan con todos los libreros y contenedores del catálogo Alea. La interacción entre elementos de diferentes colecciones es fuente de inspiración. Libreros Titano y contenedores Blade se mezclan a la perfección.*





/combinazioni di finiture

Per tutti gli elementi che compongono la serie Odeon, scrivanie e contenitori, è possibile combinare diverse finiture tra loro in maniera da personalizzare completamente l'arredo. Le moltissime opzioni di colore consentono abbinamenti sorprendenti.



***Combinations of finishes** for all Odeon elements, desks and storage units, it is possible to combine different finishes to completely customize the furniture. The many colour options allow surprising combinations.*

***Combinaisons de finitions** pour tous les éléments qui composent la série Odeon, les bureaux et les rangements, il est possible de combiner différentes finitions entre elles afin de personnaliser l'ensemble du mobilier. Les nombreuses options de couleurs permettent des combinaisons surprenantes.*

***Combinaciones de acabados** la colección Odeon ofrece varias combinaciones de acabados para escritorios y contenedores que permiten de personalizar completamente el mobiliario. La variedad de colores crean resultados sorprendentes.*





l corner legs in addition to panel leg desk with with structural lateral storage, it is also available the one with square section corner legs 90x90 mm which can be used for vertical cable transit, thanks to the use of grommets.

l pieds d'angle en plus des bureaux avec pieds panneaux et ceux constitués de rangements structurels latéraux, il y a ceux avec des pieds angulaires à section carrée de 90x90 mm, qui sont munis de passe-câbles, permettant le passage de l'électrification.

/gambe angolari

Oltre alla scrivania con gambe pannellate e con contenitore laterale strutturale, è disponibile anche quella con gambe angolari a sezione quadrata 90x90 mm che, con l'applicazione di passacavi, possono essere utilizzate per il transito dell'elettrificazione.



l patas cuadradas además del escritorio con patas paneladas y contenedor lateral estructural, también está disponible el con patas de esquinas de sección cuadrada que, con la aplicación de un pasacables, pueden usarse para el tránsito de la electrificación.





/flessibilità

Abbinamenti di diversi materiali e complementi, permettono di moltiplicare le possibili soluzioni d'arredo. L'accostamento tra le essenze del legno e gli inserti in cuoio conferiscono alla scrivania un prestigio particolare. L'utilizzo di credenze sospese con dettagli in metallo impreziosisce tutto l'ambiente.

***flexibility** being able to integrate different materials raises the design. The combination of wood, metal and leather give Odeon a particular prestige. Using suspended sideboards with painted metal detail enriches the whole environment.*

***flexibilité** favorisé par la possibilité de puiser dans différents matériaux et compléments, permet de diversifier le niveau du mobilier. Le choix des essences de bois combinées aux inserts en cuir confèrent au bureau une élégance particulière. L'utilisation de crédences suspendues avec des détails métalliques, rend tout l'environnement plus élégant.*

***flexibilidad** combinaciones de diferentes materiales y complementos permiten de incrementar las oportunidades. La combinación de madera y cuero confieren al escritorio un prestigio particular. El uso de contenedores suspendidos con detalles en metal embellece el resultado.*





I match Alea cabinets with hinged doors, combined with the Odeon series, present also the option with satin-finish or back-lacquered acrylic with anodised aluminium frame. The material has many different colours that can be combined with the wood or melamine finishes of desks and drawer units.

I assortiments les armoires Alea à portes battantes associées à la série Odeon amplifie l'offre avec des panneaux en acrylique transparents ou laqués, assemblés avec des cadres en aluminium anodisé. Ces éléments offre de nombreuses couleurs différentes qui peuvent être combinées avec les finitions en bois ou en mélamine des bureaux et des tiroirs.

I combinaciones los armarios de Alea con puertas batientes que se combinan con la colección Odeon, están disponibles en metacrilato (también lacado por detrás) con perfil en aluminio. Esto material puede ser de diferentes colores que se combinan con los acabados madera o melamina de los escritorios y cajoneras.

/abbinamenti

Gli armadi Alea ad ante battenti abbinati alla serie Odeon presentano anche l'opzione in metacrilato satinato o retro-laccato con telaio in alluminio anodizzato. Questo materiale ha molti colori diversi che possono abbinarsi alle finiture legno o melaminico delle scrivanie e delle cassettiere.





30
wed

/vetro

Il piani in vetro di Odeon presentano una cornice in alluminio perimetrale di spessore 40 mm che può essere anodizzata/spazzolata o verniciata a polveri epossidiche. I vetri sono disponibili sia nella versione retro-laccata che in quella antimpronta. Su richiesta si possono applicare gli sportelli passacavi anche sui piani in vetro.



***I glass** Odeon glass tops have a 40 mm thick perimeter aluminium frame that can be anodized/brushed or epoxy powder coated. Glass is available in both back-lacquered and anti-finger versions. On request it is also possible to apply the top accesses to the glass tops.*

***I verre** les plateaux en verre d'Odeon sont dotés d'un cadre en aluminium pouvant être anodisé/brossé ou vernis poudres époxy. Ils ont une épaisseur de 40 mm d'épaisseur. Les verres sont disponibles dans les versions rétro-laquées et anti-taches. Sur demande, les accès passe-câbles peuvent également être installés sur les étagères en verre.*

***I vidrio** los tableros en vidrio tienen un borde de aluminio extruido 40 mm de grosor en acabado brillante/anodizado o pintado epoxi. Los vidrios están disponibles en cristal retro lacado y posible tratamiento antihuella en la parte superior. A petición los tableros en vidrio pueden equiparse con pasacables.*





/briefing

Alla scrivania Odeon possono essere applicate appendici frontali "briefing" di varie dimensioni che consentono di attrezzarla per esclusivi meeting direzionali. La struttura presenta il design e i materiali della scrivania.

***/briefing** Odeon desk can be fitted with frontal briefing table in various sizes that allow to set up exclusive executive meetings. The structure is made with the same design and materials of the desk.*

***/briefing** des appendices frontaux "briefing" de différentes tailles peuvent être ajoutés au bureau Odeon lui permettant de l'équiper d'une table pour des réunions de direction "exclusives". La structure reproduit le design et reprends les matériaux du bureau.*

***/briefing** para proporcionar espacio para reuniones ejecutivas, a la mesa principal, se pueden adjuntar mesas briefing de varias dimensiones. Design y materiales son los mismos del escritorio.*



/elettrificazione

Ogni tavolo riunione Odeon, a seconda della sua struttura, prevede una soluzione per la gestione del cablaggio. Nei tavoli con basamenti metallici rotondi, il flip-top supporta una vasca per sostenere le prese e si completa con una vertebra per il transito verticale dei cavi.



***l electrification** each Odeon meeting table, depending on its structure, provides a solution for wiring management. In tables with round metal bases grommets support a basket to hold sockets and is completed with a cable duct for cables vertical transit.*

***l électrification** chaque table de réunion Odeon, selon sa structure, offre une solution pour la gestion des câbles. Les tables avec des pieds métalliques ronds, le flip-top offre un accès à une corbeille qui soutient les prises. Une vertèbre gère le transit vertical des câbles.*

***l electrificación** cada mesa de reunión contempla una solución para la electrificación en función de la estructura de la mesa. En las mesas con bases metálicas circulares una cesta para los accesorios se engancha al flip top y se completa con una vertebra para electrificación vertical.*



/tavoli modulari

I tavoli modulari sono realizzati con gambe pannellate collegate tra loro da una trave strutturale in alluminio. I tavoli possono essere estesi a qualsiasi dimensione e sono disponibili sia in melaminico che in essenza di legno.

***/modular tables** modular tables are made with panel legs connected linked by an aluminium structural beam. Tables can be extended to any size and are available both in melamine and wood veneer.*

***/tables modulaires** les tables modulaires sont fabriquées avec des pieds panneaux reliés entre eux par une poutre structurelle en aluminium. Les tables peuvent s'adapter à n'importe quelle taille et elles sont disponibles à la fois en mélamine et en placage de bois.*

***/mesas modulares** en las mesas de reunión modulares las patas están siempre revestidas de paneles, unidas entre sí por una viga estructural de aluminio. Las mesas se pueden ampliar a cualquier dimensión y están disponibles en melamina y madera.*





/inserto in pelle

Nei tavoli modulari realizzati in essenza è possibile applicare un inserto in cuoio con cuciture a contrasto. A discrezione del cliente è possibile applicare anche i top access sulla superficie rivestita.



***Leather insert** in wood modular tables it is possible to apply a leather insert with visible stitching. At the customer's discretion it is also possible to apply the top access on the upholstered surface.*

***Insert en cuir** dans les tables modulaires en bois: il est possible d'insérer une pièce ou un sous-main en cuir avec des coutures de couleur contrastantes ou pas. Selon la volonté du client, des top-access peuvent également être appliqués à la surface revêtue.*

***Inserto de cuero** en las mesas de reunión modulares en madera chapada, se puede aplicar un precioso inserto de cuero. A petición del cliente es posible aplicar los top access en la superficie tapizada.*







***I tidiness** the structural beam used to connect legs and support table tops provides space for horizontal cable management. In fact, top accesses are placed directly on it and exploit the cavity.*

***L'ordre** la poutre structurelle utilisée pour relier les jambes entre-elles et à la fois soutenir le dessus de la table, elle offre un espace pour le passage ordonné des câbles horizontalement. Les top access sont positionnés directement sur elle et profitent de son espace intérieur.*

***l'orden** la viga estructural que se utiliza para la unión de las patas permite el tránsito de los cables en sentido horizontal. El top access se coloca por encima en correspondencia de la viga aprovechando del espacio en su interior.*

/ordine

La trave strutturale utilizzata per collegare tra loro le gambe e supportare i piani del tavolo, offre lo spazio per il transito ordinato dei cavi in senso orizzontale. I top access infatti sono posizionati direttamente su di essa e ne sfruttano la cavità.



/finiture piano | top finishes | finitions plateau | acabados sobre



Melaminico senza (A) e con profilo (B)*
 Italian melamine without (A) and with profile (B)*
 Méla mine sans (A) et avec profil (B)*
 Melaminico sin (A) y con perfil (B)*



Legno senza (C) e con profilo (D)*
 Wood veneer without (C) and with profile (D)*
 Bois sans profilé (C) et avec profilé (D)*
 Madera sin (C) y con perfil (D)*



Cuoio (E), vetro (F) e gres (G) con profilo*
 Leather (E), glass (F) and porcelain tiles (G) with profile*
 Cuir (E), verre (F) et grès (G) avec profil*
 Cuero (E), vidrio (F) y gres porcelánico (G) con perfil*

***Il profilo metallico del piano può avere le seguenti finiture: anodizzato, brill, epossidico**
 *The metal profile of the table top, can have the following finishes: anodised, brill, epoxy
 *Le profil métallique du dessus peut avoir les finitions suivantes: anodisé, brillant, époxy
 *El perfil metálico del sobre puede ser anodizado, brillante, pintado epoxy



/forme dei piani | desk top shapes | formes de plateaux | formas de sobres

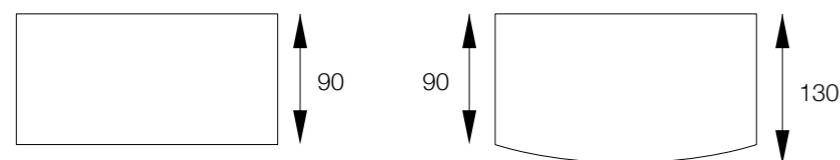

/gambe | legs | pieds | patas

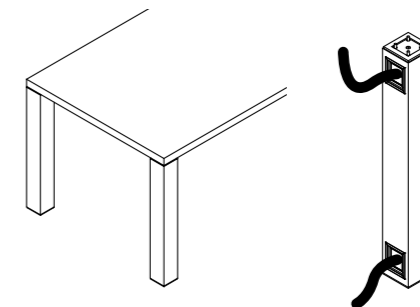
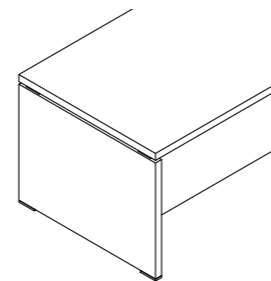

gambe pannellate legno/melaminico
 panel legs - wood veneer/Italian melamine
 piètements panneaux - bois/méla miné
 patas paneladas - madera/melaminico

gambe angolari legno/melaminico
 corner legs - wood veneer/Italian melamine
 piètements d'angle - bois/méla miné
 patas angulares - madera/melaminico

/scrivania singola | single desk | bureau individuel | mesa individual

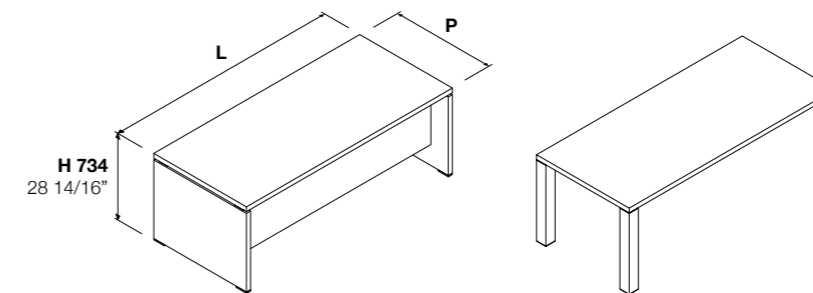

	L 1800 70 14/16"	L 2000 78 12/16"			
P 900 35 7/16"	•	•			

/scrivania con muretto | desk with extended leg | bureau avec pied panneau prolongée | mesa con costado lateral

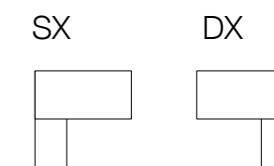
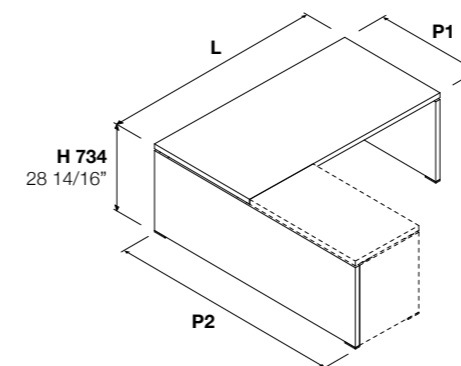

	L 1800 70 14/16"	L 2000 78 12/16"			
P1 900 35 7/16"	•	•			
P2 1900 74 13/16"					
P1 900 35 7/16"	•	•			
P2 2100 82 11/16"					

/scrivania per mobile di servizio | desk for service unit | bureau pour meuble retour | mesa para mueble auxiliar

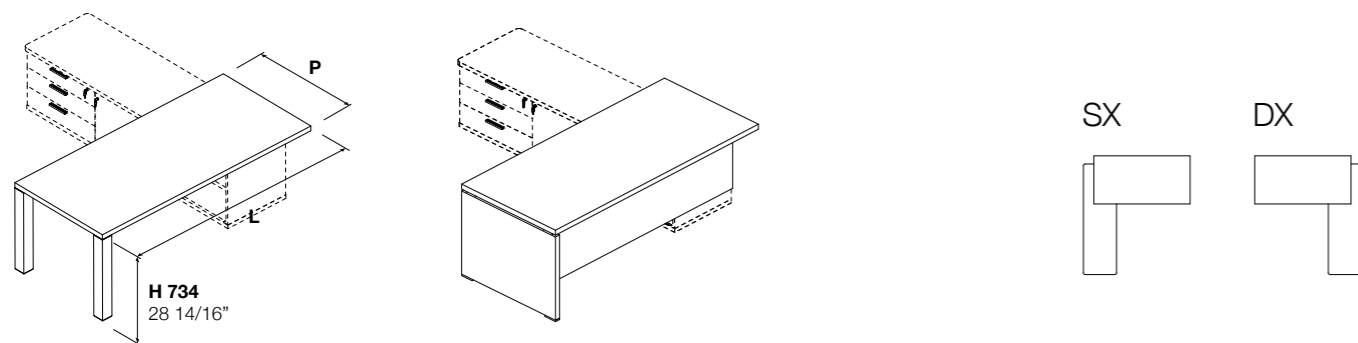

	L 1800 70 14/16"	L 2000 78 12/16"			
P 900 35 7/16"	•	•			

/dattilo agganciati e indipendenti | hanging and freestanding returns | retours accrochés et indépendants | alas suspendidas y independientes

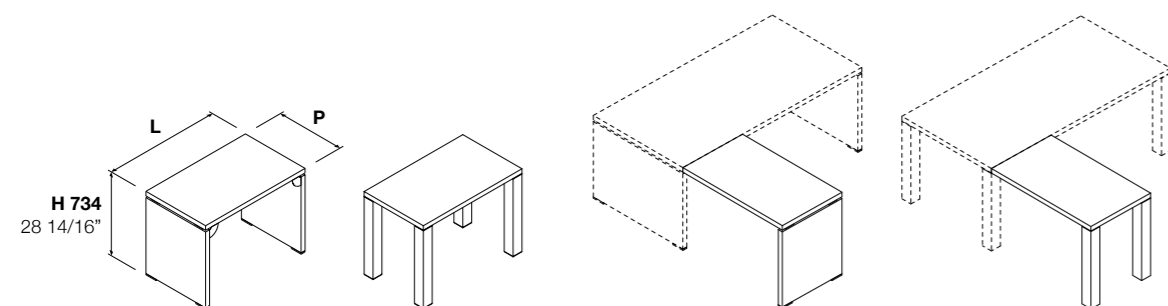

	L 1000 39 6/16"	L 1200 47 4/16"			
P 600 23 10/16"	•	•			

/briefing | briefing | briefing | briefing

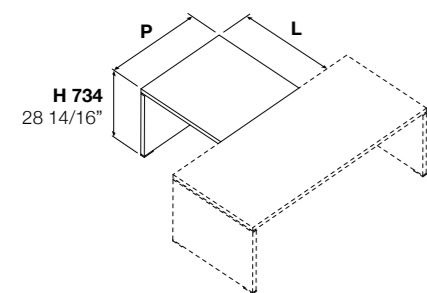

	L 900 35 7/16"	L 1800 70 14/16"			
P 800 31 8/16"	•				
P 900 35 7/16"		•			

/tavoli quadrati e rotondi con basamento metallico | square and round tables with metal base | tables carrées et rondes avec base en métal | mesas cuadradas y redondas con base de metal

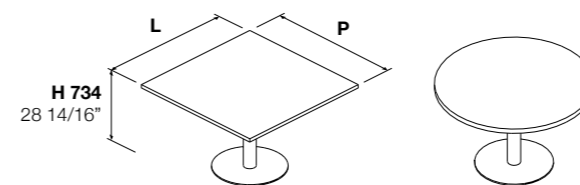

L/P 800 31 8/16"	L/P 900 35 7/16"	L/P 1000 39 6/16"	L/P 1200 47 4/16"		
•	•	•	•		

/tavoli riunione quadrati | square meeting tables | tables de réunion carrées | mesas de juntas cuadradas

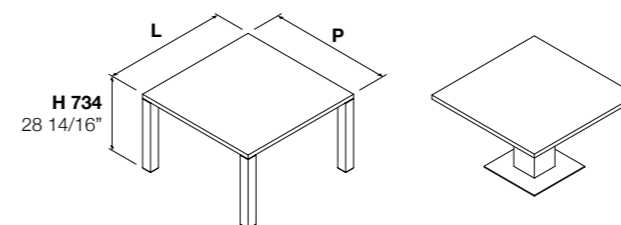

L/P 800 31 8/16"	L/P 900 35 7/16"	L/P 1000 39 6/16"	L/P 1200 47 4/16"	L/P 1300 51 3/16"	L/P 1500 59 1/16"
•	•	•	•	•	•

/tavoli riunione | meeting tables | tables de réunion | mesas de juntas

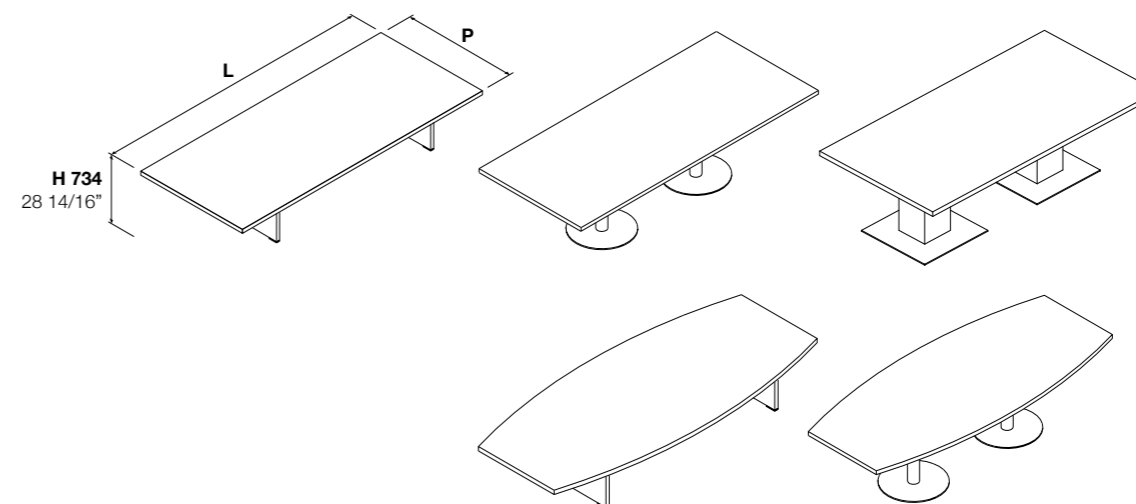

	L 2100 82 11/16"	L 2800 110 4/16"			
P 1200 47 4/16"	•	•			

/tavoli riunione | meeting tables | tables de réunion | mesas de juntas

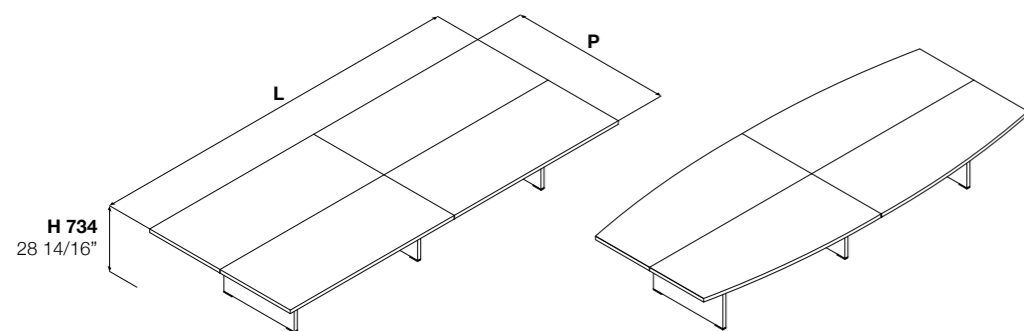

	L 4200 165 6/16"				
P 1800 70 14/16"	•				

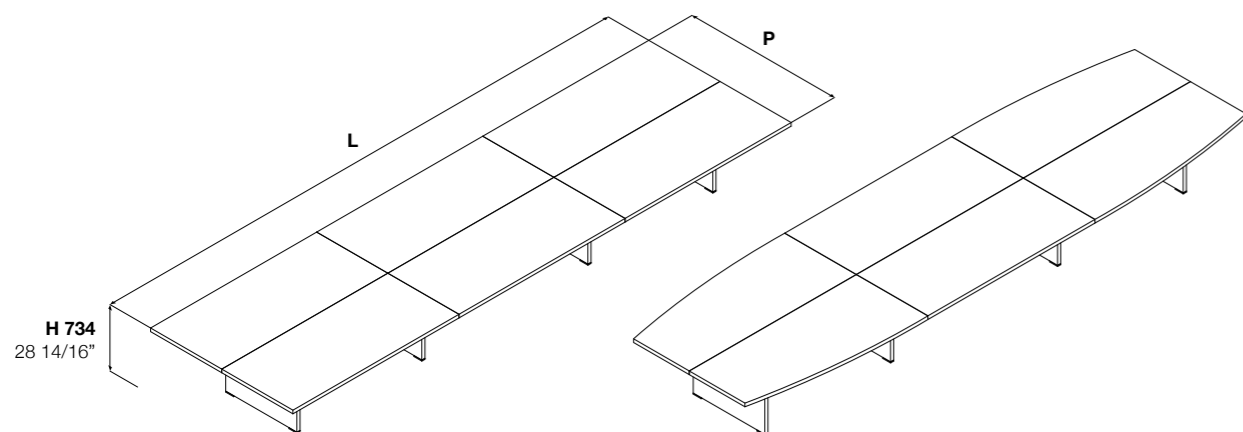

	L 4900 192 15/16"	L 5600 220 8/16"	L 6300 248"		
P 1800 70 14/16"	•	•	•		

/tavolini da caffè | coffee tables | tables basses | mesitas

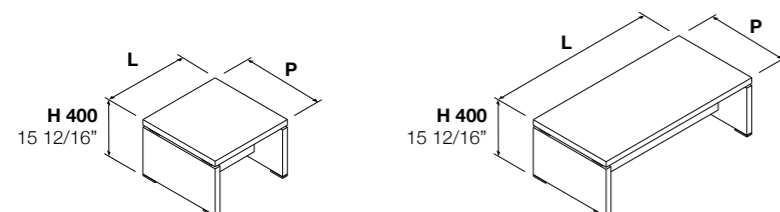

	L 600 35 7/16"	L 1200 47 4/16"			
P 600 31 8/16"	•	•			

mobile di servizio fisso | freestanding service unit | meuble retour fixe sur patins | mueble auxiliar con pies

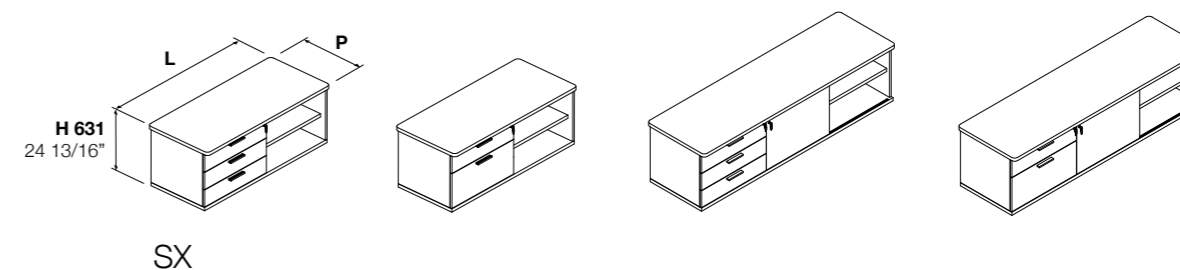

	L 1385 54 8/16"	L 1800 70 14/16"	L 2067 81 6/16"		
P 598 23 9/16"	•	•	•		

Mobili di servizio su ruote | mobile service unit with casters | meuble retour mobile sur roulettes | armarios con ruedas

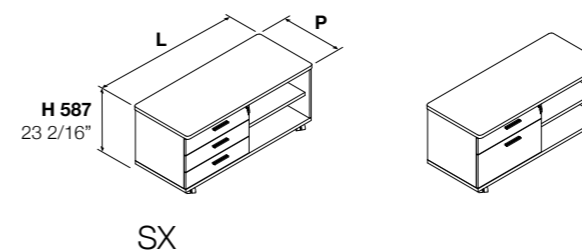

	L 1385 54 8/16"				
P 598 23 9/16"	•				











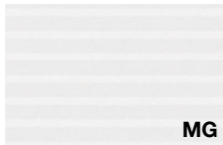



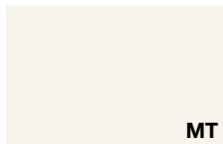

Finiture | Finishes | Finitions | Acabados

MEL

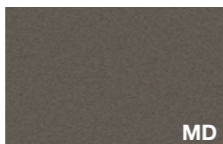
Melaminico

Melamine | Mélaminé | Melaminico

TOP MOB MOD







 MB	 MG	 MF	 MZ	 MN
Bianco rigato Rippled effect white Blanc avec rayures en sérigraphie Blanco rayado	Grigio rigato Rippled effect grey Gris avec rayures en sérigraphie Gris rayado	Nichel Nickel Nickel Niquel	Cacao Cocoa Cacao Cacao	Bianco White Blanc Blanco
 MT	 MJ	 MK	 MI	 MV
Talco Talco Talco Talco	Ocra Ochre Ocre Ocre	Safari Safari Safari Safari	Noisette Noisette Noisette Noisette	Verde Green Vert Verde
 ML	 MQ	 MD	 MC	 MY
Nero Black Noir Negro	Blu notte Night blue Bleu nuit Azul noche	Ardesia Ardesia Ardesia Pizarra	Rovere chiaro Light oak Chêne clair Roble claro	Rovere americano American oak Chêne américain Roble americano
 ME	 MM	 MO	 MW	
Rovere grigio Grey oak Chêne gris Roble gris	Rovere moro Dark oak Chêne foncé Roble oscuro	Noce Canaletto Canaletto Walnut Noyer Canaletto Nogal Canaletto	Noce scuro Dark walnut Noyer foncé Nogal oscuro	

LGN

Legno

Wood | Bois | Madera

TOP MOB MOD









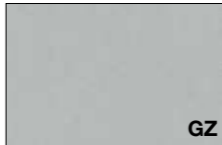

 RC	 RG	 RM	 NO	 SL
Rovere chiaro Light oak Chêne clair Roble claro	Rovere grigio fumo Smoke grey oak Chêne gris de fumée Roble gris humo	Rovere moro Dark oak Chêne foncé Roble oscuro	Noce Canaletto Canaletto walnut Noyer Canaletto Nogal Canaletto	Ebano silver Silver ebony Ebony silver Ebano plata
 AK	 NT			
Ebano Makassar Makassar ebony Ebony Makassar Ebano Makassar	Noce termocotto Heat-treated walnut Noyer thermo traité Nogal termotratado			

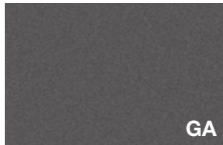
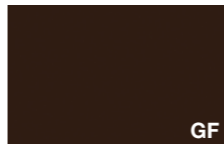
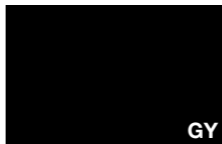
VTR

Vetro (anche antimpronta NFG)

Glass (also antifinger NFG) | Verre (également antitaches) | Vidrio (también anti-huella)

TOP





 GW	 GZ	 GK	 GN	 GA
Bianco White Blanc Blanco	Argento Silver Argent Plata	Grigio scuro Dark grey Gris foncé Gris oscuro	Noisette Noisette Noisette Noisette	Ardesia Ardesia Ardesia Pizarra
 GF	 GY	 GX	 GQ	 GO
Moka Mocha Moka Café	Nero Black Noir Negro	Arancione Orange Orange Naranja	Rosso "F" Red "F" Rouge "F" Rojo "F"	Rubino Ruby Rubis Rubi
 GD	 GT	 GU	 GR	
Indaco Indigo Indigo Azul Indigo	Azzurro Blue Bleu Azul	Verde Green Vert Verde	Cedro Lime green Vert Cédtrat Verde Cedro	

GRES

Gres porcellanato

Porcelain tiles | Grès cérame | Gres porcelánico

TOP

 JN	 JB	 JC	 JP	 JR
Nero Black Noir Negro	Basalt Basalt Basalt Basalt	Calacatta Calacatta Calacatta Calacatta	Pulpis Pulpis Pulpis Pulpis	Corten Corten Corten Corten

CUO

Cuoio

Leather | Cuir | Cuero

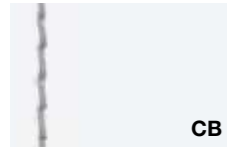

Bianco
White
Blanc
Blanco



Alluminio
Aluminium
Aluminium
Aluminio



Nero
Black
Noir
Negro



Testa di moro
Brown
Tete de maure
Marron oscuro



Caramello
Caramel
Caramel
Caramelo

TOP



Arancione
Orange
Orange
Naranja

EPX

Epossidico

Epoxy | Époxy | Epoxi



Bianco
White
Blanc
Blanco

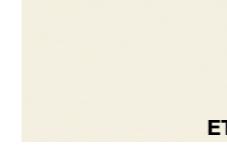

Talco
Talco
Talco
Talco

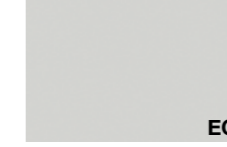

Grigio
Grey
Gris
Gris

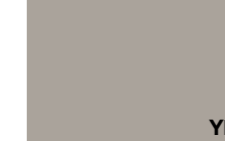

Beige Arizona
Arizona beige
Beige Arizona
Beige Arizona



Noisette
Noisette
Noisette
Noisette



Safari
Safari
Safari
Safari



Rame
Copper
Cuivre
Cobre

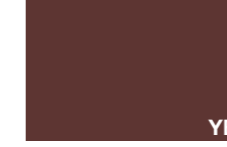

Rosso Jaipur
Jaipur red
Rouge Jaipur
Rojo Jaipur

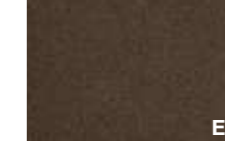

Bronzo
Bronze
Bronze
Bronze



Blu notte
Night blue
Bleu nuit
Azul noche



Grigio Bromo
Bromo grey
Gris Bromo
Gris Bromo

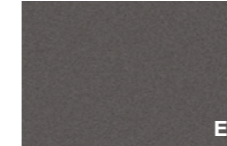

Ardesia
Ardesia
Ardesia
Pizarra



Verde Comodoro
Comodoro green
Vert Comodoro
Verde Comodoro



Nero
Black
Noir
Negro

PR

STRU

BR

Alluminio

Aluminium | Aluminium | Aluminio



Brill
Brill
Brill
Brill

PR

Applicazioni finiture

Finish application | Application finitions | Aplicacion acabados



Piano
Top
Plateau
Sobre



Modesty panel
Modesty panel
Voile de fond
Faldón



Mobile di servizio
Service unit
Meuble de service
Mueble de servicio



Struttura
Structure
Structure
Structura



Profilo scrivania
Top edge
Chant plateau
Perfil sobre de mesa

Ambiente e sicurezza | Environment and safety | Environnement et sécurité | Medio ambiente y seguridad

Alea utilizza per i suoi prodotti e i suoi imballi materiali facilmente separabili e riciclabili.
Nella produzione dei suoi manufatti, Alea si impegna ad utilizzare materiali legnosi FSC e pannelli a base di legno con certificazione CARB2. I pannelli CARB2 presentano un rilascio di formaldeide inferiore rispetto al pannello E1 comunemente utilizzato (classe E1 secondo il DM 10/10/2008).

Alea uses materials that are easy to separate and recycle for its products and packaging.
Alea is committed to using FSC wood-based materials and CARB2-certified wood-based panels.
CARB2 panels have a lower formaldehyde release than the commonly used E1 panel (class E1 according to DM 10/10/2008).

Alea utilise des matériaux facilement séparables et recyclables pour ses produits et ses emballages.
Dans la production de ses produits, Alea s'engage à utiliser des matériaux en bois FSC et des panneaux à base de bois avec la certification CARB2. Les panneaux CARB2 dégagent moins de formaldéhyde que le panneau E1 couramment utilisé (classe E1 selon DM 10/10/2008).

Para sus productos y embalajes, Alea utiliza materiales fácilmente separables y reciclables.
En la fabricación de sus productos, Alea se compromete a utilizar materiales de madera FSC y paneles de madera con certificación CARB2. Los paneles CARB2 tienen una menor liberación de formaldehído que el panel E1 comúnmente utilizado (clase E1 según DM 10/10/2008).

Concept, visual & graphic design

Alea marketing + communication

Design

Mirto Antonel

Art direction

Mirto Antonel

Si ringrazia M.artedesign

martedesign.it

AD/CACD/AD

alea
aleaoffice.com



GLOBAL HEADQUARTERS AND SHOWROOM : Via Col de Rust, 19 - 33070 Sarone (PN) - Italia : Tel ++39 0434 777 333
email: info@aleaoffice.com **PARIS SHOWROOM** : 176 Avenue Charles de Gaulle 92200, Neuilly-sur-Seine - France **NORTH AMERICAN
HEADQUARTERS** : Midtown 2, 3449 NE 1st Avenue L-32, Miami, FL 33137 - USA : Tel ++1 305 470 1200 - email: info@alea-usa.com
ALEA UK OFFICE AND SHOWROOM : 50-54 Clerkenwell Road, London EC1M 5PS - email: info@aleaoffice.com